

M
I
C
R
O
C
E
M
E
N
T



PORTFOLIO

FØRST

FØRST

Silhouette
of Nature





M A R M O R I N O  F L O O R

Объемно-пространственное и стилистическое решение в интерьере во многом определяет особенность его локации. Расположение на пересечении двух стихий: транспорта и воды (Москва реки) определили ландшафтную и видовую знаковость данного объекта - как локальную, так и городскую. В своем решении архитекторы бюро «WALL» в качестве отделочных материалов для стен, потолков и полов применили изящное решение двух материалов: натуральное дерево и бетонные поверхности из микроцемента PRATTA MARMORINO X FLOOR.

Пространственная структура и образ объекта цитирует скальные образования, характерные для морских ландшафтов. Мономатериальность объекта, его скульптурность олицетворяет тектоничность и монументальность природных скальных образований.

Архитектурное Бюро «WALL»

The spatial and stylistic solution of an area largely determines the peculiarity of its location. The location at the intersection of two elements: transport and water - the Moscow River, determined the landscape and specific significance of the object - both local and urban. In their decision, the architects of the WALL bureau used an elegant solution of two materials as finishing of walls and floors: natural wood and concrete surfaces made of microcement PRATTA MARMORINO X FLOOR.

The spatial structure and imagery of the object cites rock formations typical of seascapes. Monomateriality of the object, its sculptural character embodies the tectonicity and monumentality of natural rock formations.

By architects of the «WALL» bureau



FÜRST

Hall Set Interior



MICROCEMENT DESIGN

walls & reception / стены и ресепшн
floor / полы

Interior & Exterior / Интерьерное-Экстерьерное





MARMORINO **X** FLOOR

IDEA CODE: 700

MICROCONCRETE FOR WALLS AND FLOORS

FØRST

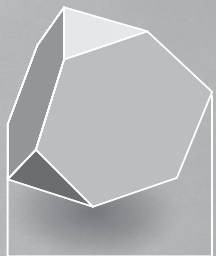

1,2-1,5 mm

COARSE



0,7-1 mm

MEDIUM



0,3-0,5 mm

FINE

Floor system

I Preparation / Подготовка

1 PRIMER NORMAL (грунт пропитка)

II Decorative base / Декоративная база

2 MARMORINO X FLOOR COARSE

3 MARMORINO X FLOOR MEDIUM

4 MARMORINO X FLOOR FINE

III Protection / Защита

5 VETRIFICANTE POLIURETHANICO

(защитное покрытие)

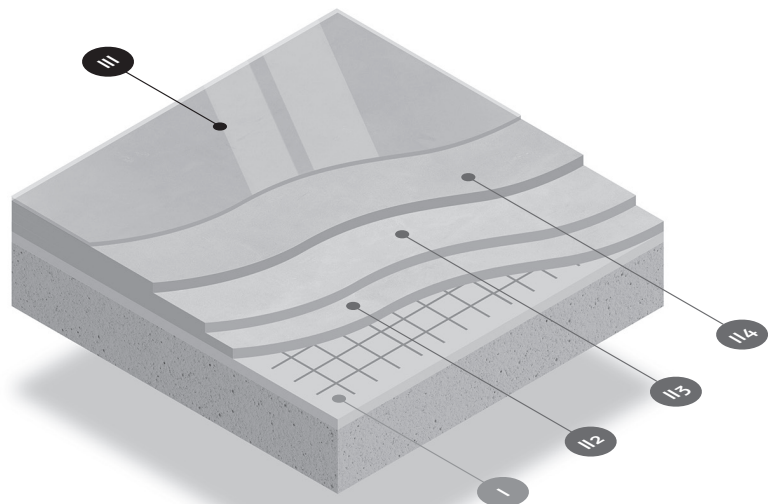

Wall system

- I Preparation / Подготовка
 - 1 PRIMER NORMAL (грунт пропитка)
- II Decorative base / Декоративная база
 - 2 MARMORINO X FLOOR MEDIUM
 - 3 MARMORINO X FLOOR FINE
- III Protection / Защита
 - 4 VETRIFICANTE POLIURETHANICO (защитное покрытие)

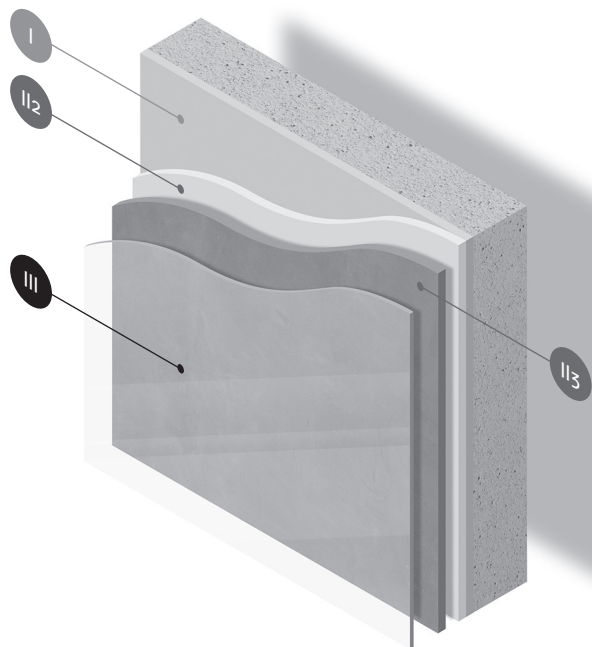

A modern interior space featuring a white reception desk in the foreground. The desk has the word "FØRST" printed on its right side. The background consists of walls and a ceiling made of light-colored wood panels. A black track lighting fixture with four spotlights is mounted on the ceiling. To the left, a glass partition with a black frame is visible. The floor is a light, neutral color.

FØRST



MARMORINO X FLOOR – Специальное бесшовное покрытие для стен и полов на основе микроцемента. Это система, которая создает покрытия без швов и границ, связывает между собой полы и стены современным и уникальным декоративным решением. Может использоваться в любом пространстве – от кухни до гостиной, в общественных и коммерческих помещениях, а также для отдельных элементов интерьера, мебели и столешниц.

MARMORINO X FLOOR – this is a special material for walls and floors, which allows you to create seamless surfaces without joints in accordance with the latest trends in architecture and design with various types of natural effects and more than 1000 colors and shades. This is an ideal system for both combined walls and floors, which can be connected with another details of interior - the decor of various furniture elements, tables and so on.



EXTERIOR



INTERIOR



ENVIRONMENT



LOCAL-REPAIR



VANDAL-PROOF



M A R M O R I N O X F L O O R







PRATTA MATERIALS
INFORMATION



VETRIFICANTE POLIURETHANICO – однокомпонентный прозрачный лак на водной основе для защиты декорированных поверхностей интерьеров и экстерьеров. Первостепенный финишный лак, специально разработанный для системы MARMORINO X FLOOR и предназначенный для защиты готового декора, включая поверхности стен, мебели, столов и все типы горизонтальных поверхностей, от влаги и загрязнений.

VETRIFICANTE POLIURETHANICO – is polyurethane clear finish mono-component on a water based. To be used as a protective coat for exteriors and interiors, for protection of walls, furniture, tables and all types of horizontal surfaces. Created special for MARMORINO X FLOOR System.



EXTERIOR



INTERIOR



ENVIRONMENT



MARMORINO X FLOOR part A

Liquid mineral mixture part A
Пастообразная смесь часть А

MARMORINO X FLOOR	grain size размер гранул	consumption расход
Coarse	1,2 - 1,5 mm	2,4 - 3 kg / 1 m ²
Medium	0,7-1 mm	1,5 - 2 kg / 1 m ²
Fine	0,3-0,5 mm	1 - 1,3 kg / 1 m ²



1,2-1,5 mm
Coarse



0,7-1 mm
Medium



0,3-0,5 mm
Fine



COMPONENT B (MF)

Dry powder additive microconcrete based
Сухая добавка на микроцементной основе

COMPONENT B (MF) + MARMORINO X FLOOR Part A
4 кг / kg + 20 кг / kg
5.4 кг / kg + 18 кг / kg

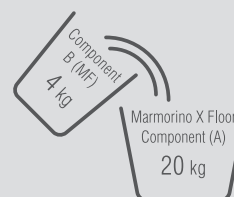

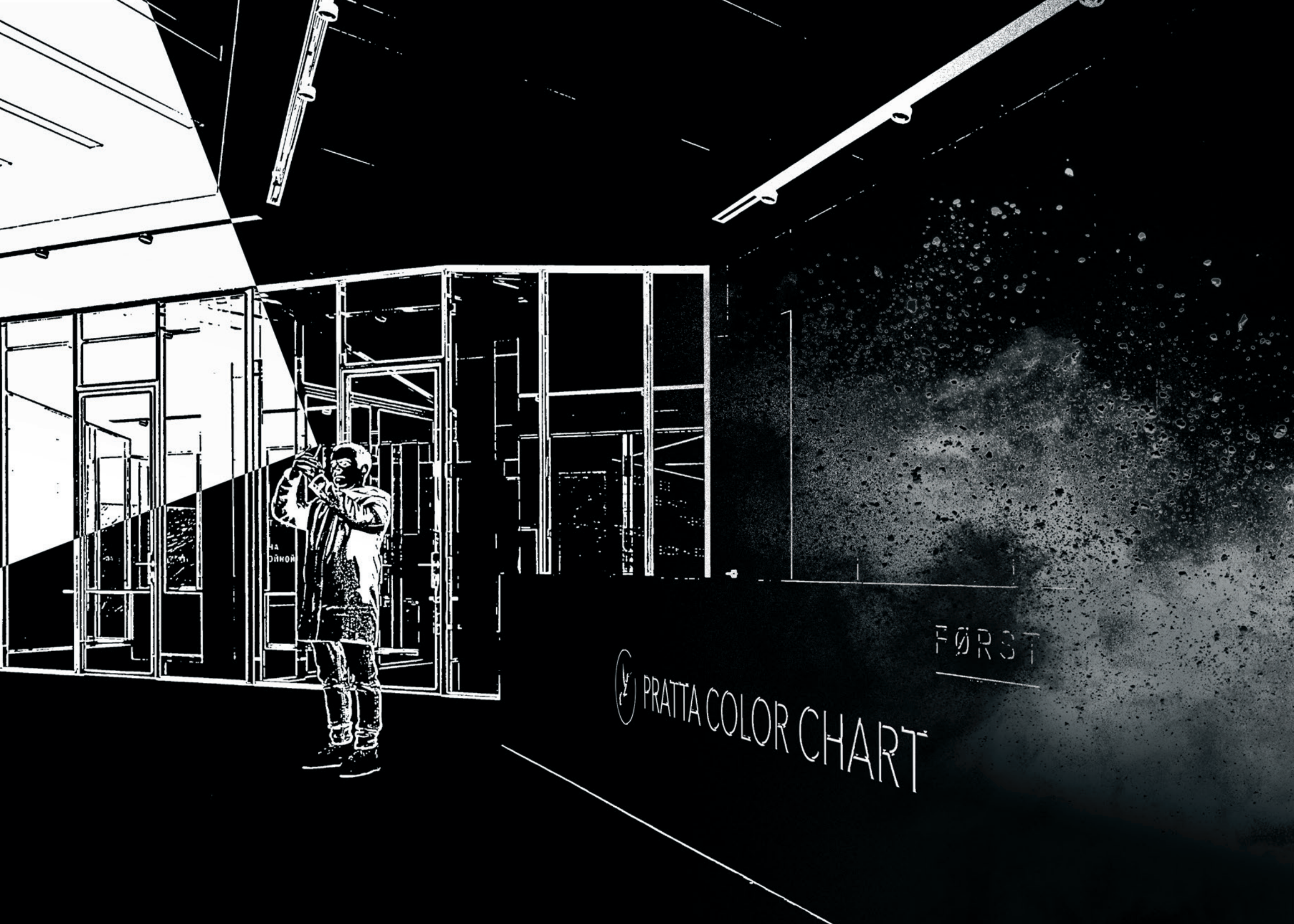

PRATTA COLOR CHART

FØRST

from Ivory & Grey SPECIAL COLOR CHART FOR «FORST» PROJECT

Portland Stone
Portland Stone

77B P
77B P

Mid Lead
Colour

114G P

Perennial Grey

Grey Teal
Grey Teal

226G P

French Grey
French Grey

245B P

Scree
Scree

French Grey
Dark
French Grey
Dark

163B P
163B P

227G P
227G P

113G P
113G P

from Ivory & Grey

SPECIAL COLOR CHART FOR «FORST» PROJECT / REAL SAMPLES MADE OF «MANU»

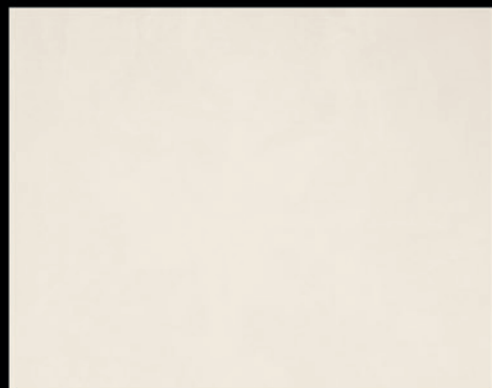

Portland Stone Pale

155B P

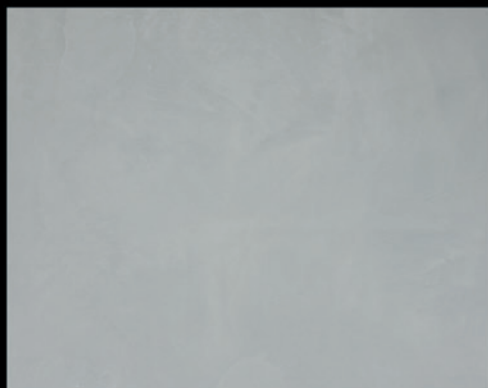

Urbane Grey

225G P

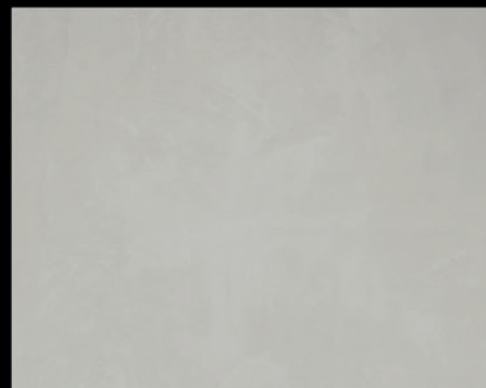

Mortar

239G P

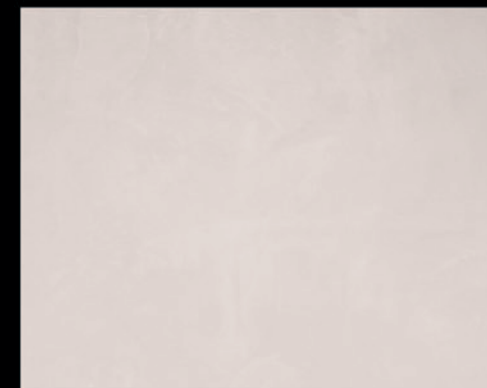

China Clay Mid

176B P

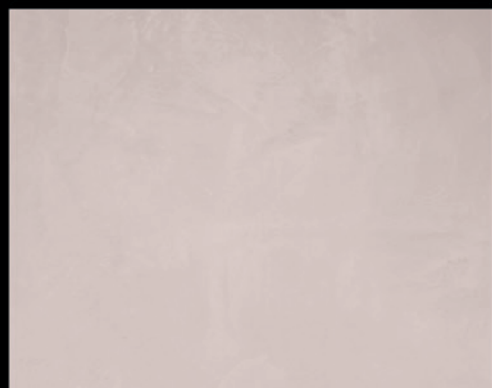

Rubine Ashes

243B P

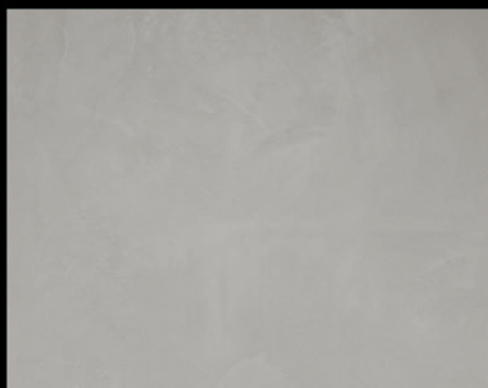

Serpentine

233G P



Limestone

238G P

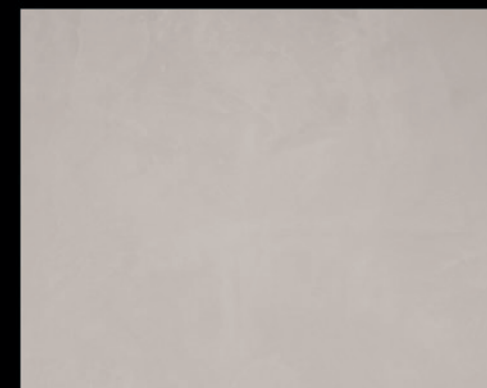

Mushroom

142B P

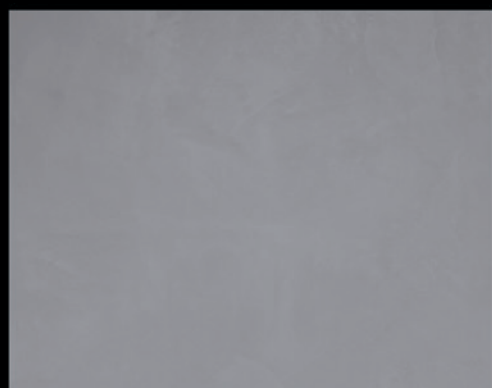

Dark Lead Colour

118G P



Grey Moss

234G P



Pearl Colour Dark

169G P



Juniper Ash

115G P

Also color chart for tinting the «MANU»

from Ivory & Grey

SPECIAL COLOR CHART FOR «FORST» PROJECT / REAL SAMPLES MADE OF «MANU»

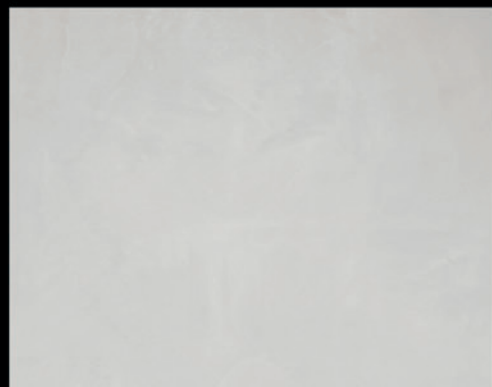

French Grey Pale

161B P



Wood ash

229G P



French Grey Mid

162B P



Shallows

223G P

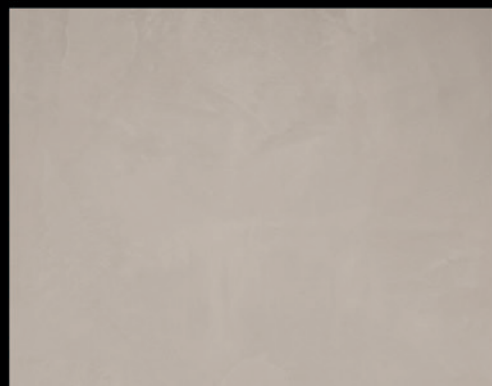

Rolling Fog

143B P

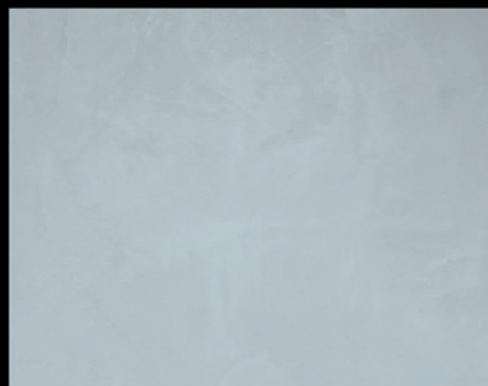

Inox

224G P

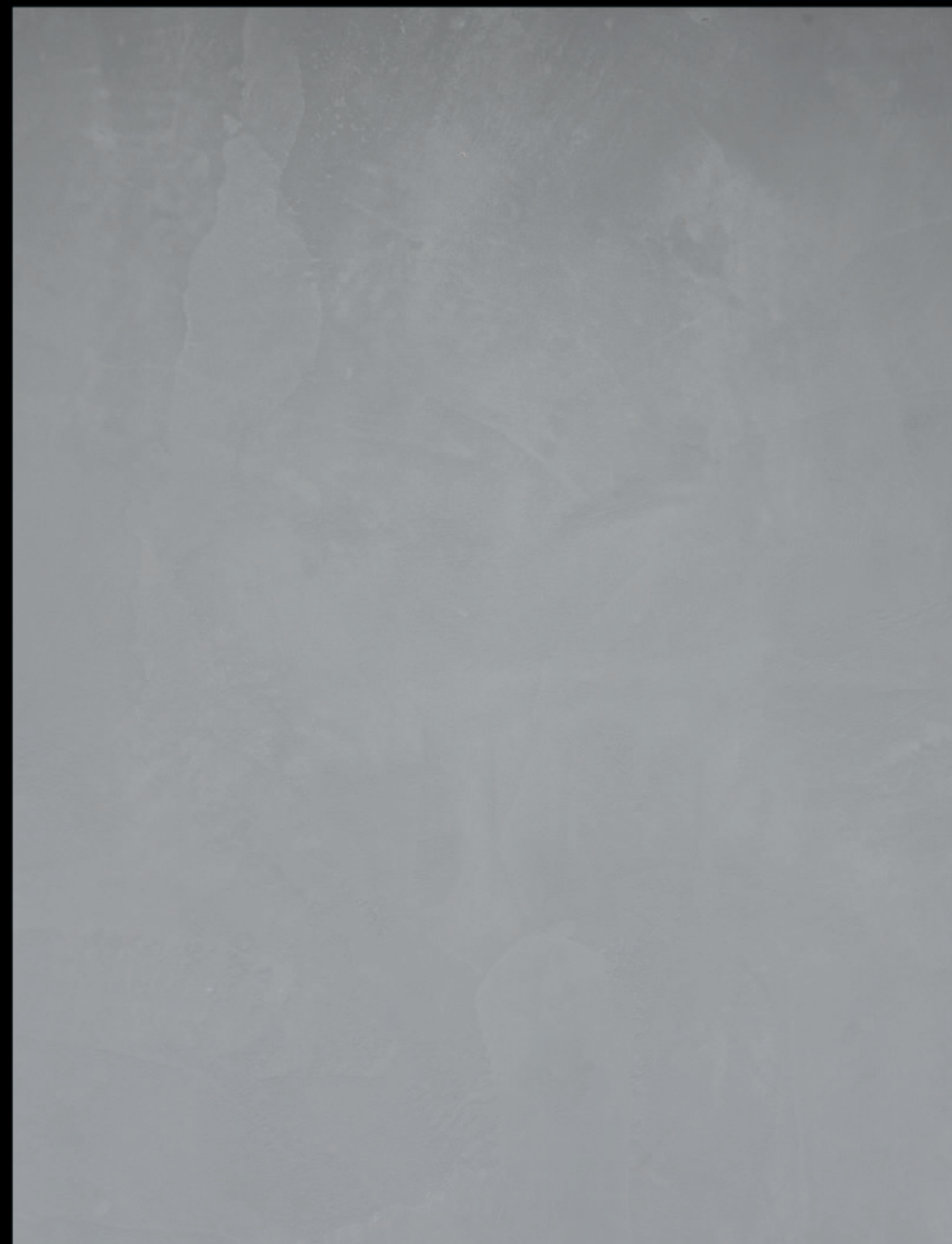

Lead

117G P

Also color chart for tinting the «MANU»

M I C R O C E M E N T

www.orsochem.ru | www.pratta.xyz

MARMORINO X FLOOR

FØRST

The project by «WALL»

